

EP04-Monte - Sistem za izradu kliznih vrata

EP04-Monte Sistem za izradu kliznih vrata nosivosti do 60kg

Sistem podržava debljinu iverice 10mm ili staklo 4mm. Karakteristike: lako sklapanje, skoro bežuman rad točkica i pouzdani setovi usporivača. Za sklapanje ovih vrata mogu se koristiti samo asimetrični točkici. Usporivač koji odgovara ovom sistemu je **EP04-Monte** nosivosti do 50kg.

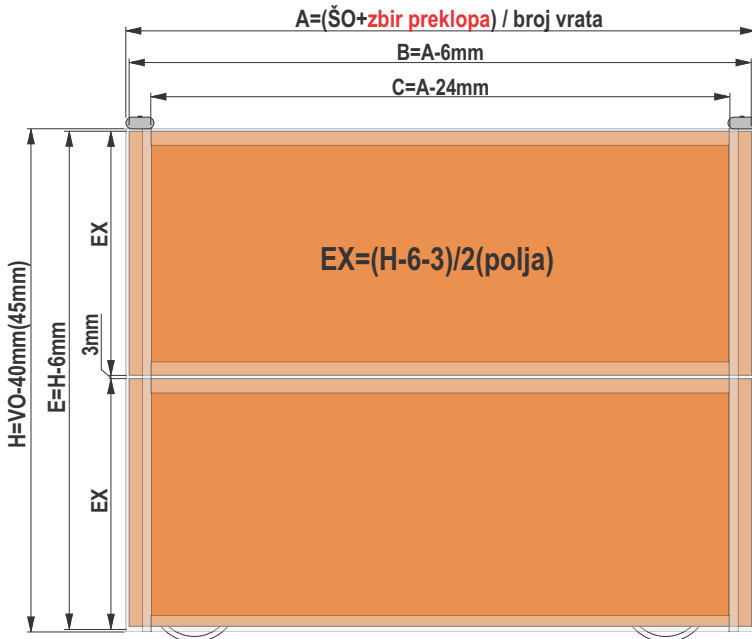

- A - Širina vrata
- ŠO - Širina otvora
- B - Širina ispune
- C - Širina G+D vođice i H profila
- H - Visina vrata
- VO - Visina otvora
- E - Visina ispune
- EX - Visina ispune ukoliko ide pregradni profil

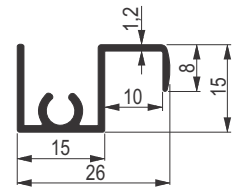

	šifra
m srebro	3641
m bronza	3779
m sjaj	3783

EP04-32 Gornja vođica

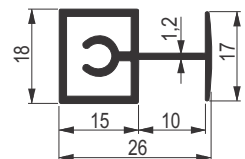

	šifra
m srebro	3642
m bronza	3781
m sjaj	3785

EP04-33 Pregradni profil

Visina vrata umanjuje se za 40mm ako na vrata stavljamo asimetrične točkice, a ako stavljamo usporivač EP04-Monte visina vrata umanjuje se za 45mm.

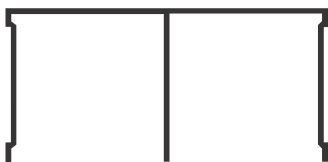

	šifra
1÷6 m srebro	388
1÷6 m bronza	514
1÷6 m sjaj	3854

EP10-76
dvokanalna gornja šina

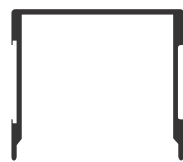

	šifra
1÷6 m srebro	487
1÷6 m bronza	1591

EP10-884
jednokanalna gornja šina



	šifra
1÷6 m srebro	390
1÷6 m bronza	510
1÷6 m sjaj	3853

EP10-74
donja šina



	šifra
1÷6 m srebro	479
1÷6 m bronza	1592

EP10-885
jednokanalna donja šina

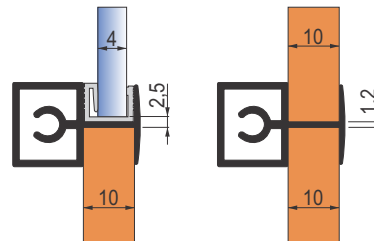

	šifra
3m siva	395

PVC ispuna
EP-28025 Siva

	šifra
3m providna	673

PVC ispuna
EP-28018 Providna

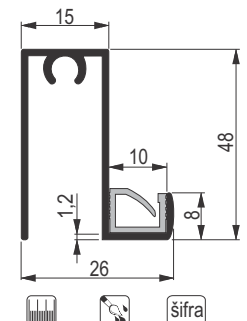

	šifra
m srebro	3643
m bronza	3780
m sjaj	3784

EP04-35 Donja vođica

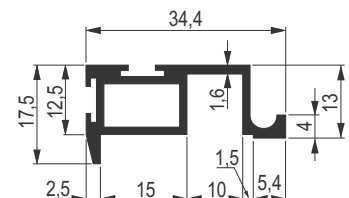

	šifra
m srebro	3640
m bronza	3778
m sjaj	3782

EP04-38 Rukohvat

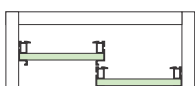

1 preklop=13mm

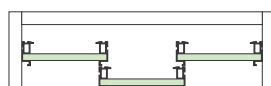

2 preklopa=26mm

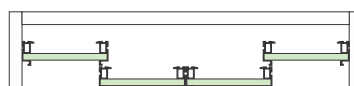

2 preklopa=26mm

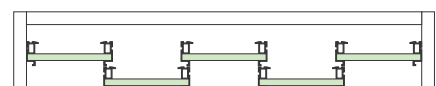

4 preklopa=52mm

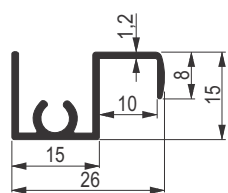

EP04-32 Gornja vodica

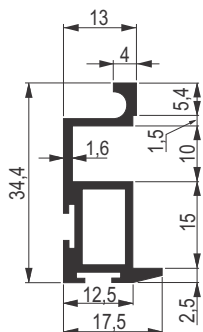

EP04-38 Rukohvat

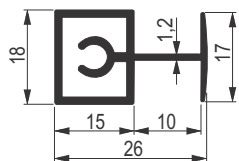

EP04-33 Pregradni profil

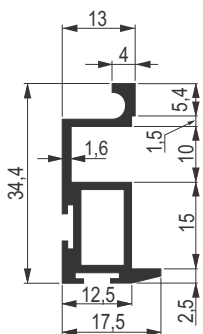

EP04-38 Rukohvat

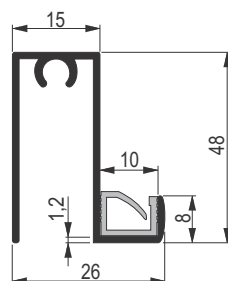

EP04-35 Donja vodica

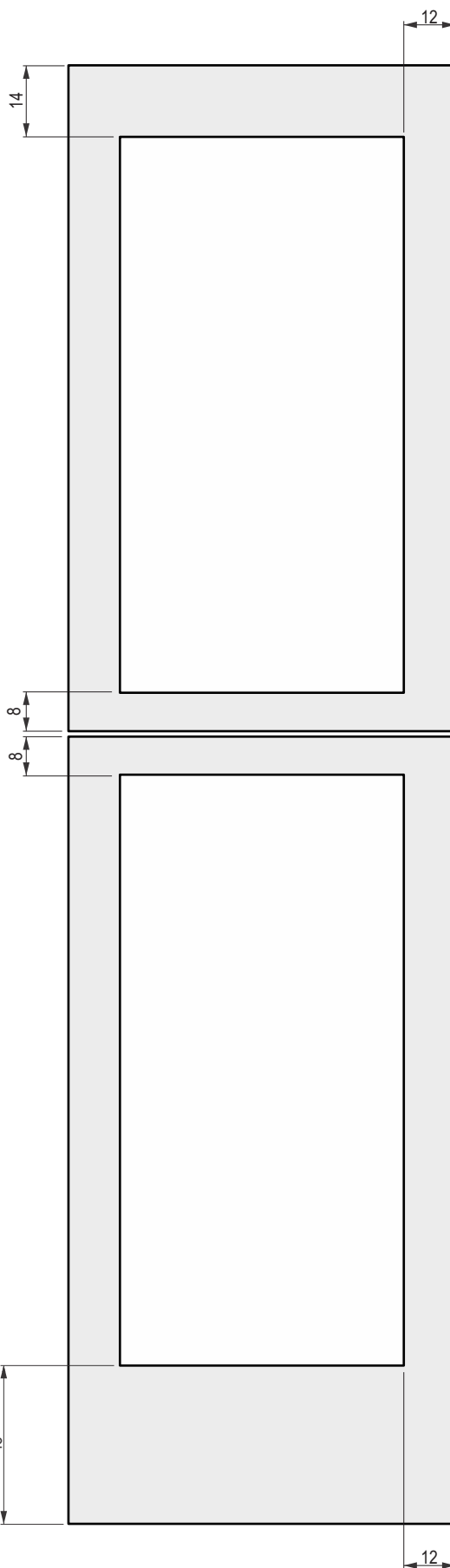

Pogled sa zadnje strane

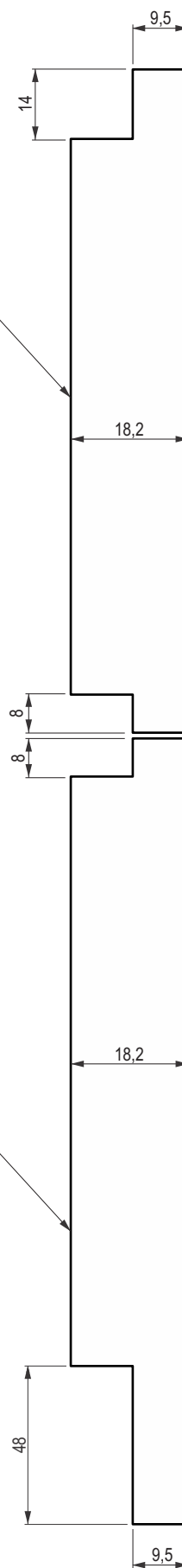

Pogled sa zadnje strane

Pozicija rupa na Al rukohvatima za gornju i donju vodicu i mehanizam

EP04-32 Gornja vodica

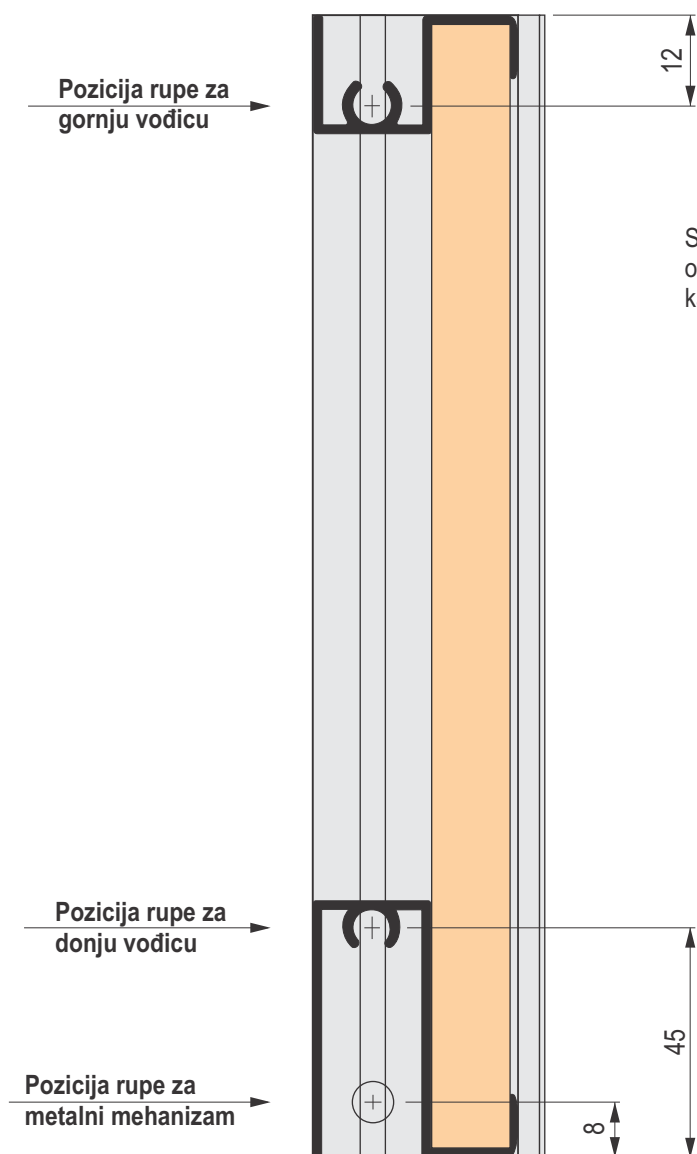

Sa burgijom $\varnothing 5$ prvo razbušite prvi i drugi zid rukohvata, onda sa burgijom $\varnothing 10$ razbušite samo prvi zid kako bi se dobio prostor dovoljan da prođe glava šrafa.

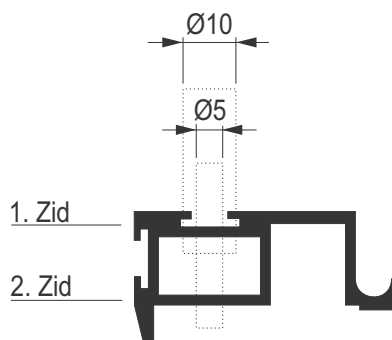

Al rukohvat

EP04-35 Donja vodica

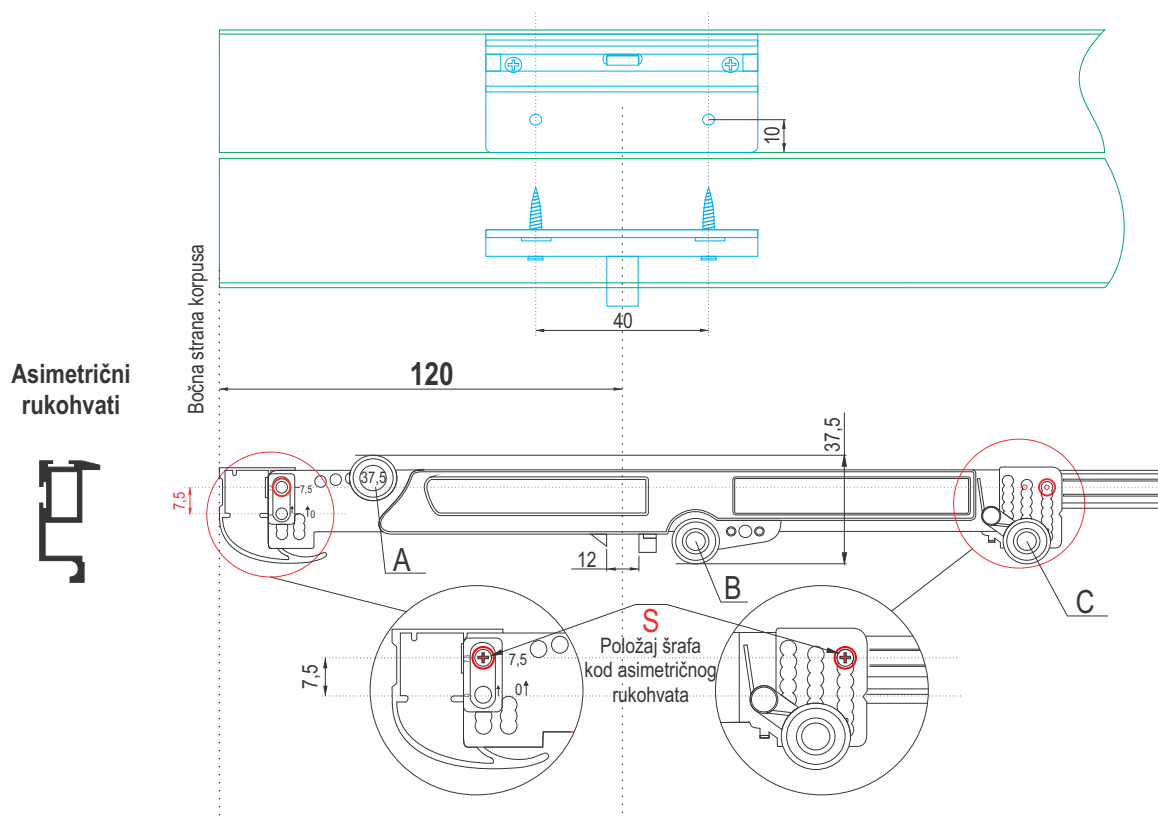

EP04-Monte mehanizam Soft Close standard



EP04-Monte mehanizam Soft Close veća nosivost



EP04-Monte mehanizam podesivi standard 45kg.



EP04-Monte mehanizam podesivi veća nosivost 60kg.