

**Pocket sistem profila za izradu skrivenih drvenih i staklenih vrata**

  
40/50/80kg

**Drvo** 30mm  
45mm

**Staklo** 8mm  
10mm

700mm  
MIN

PVD Evolution Fluid mehanizmi 50 i 80kg

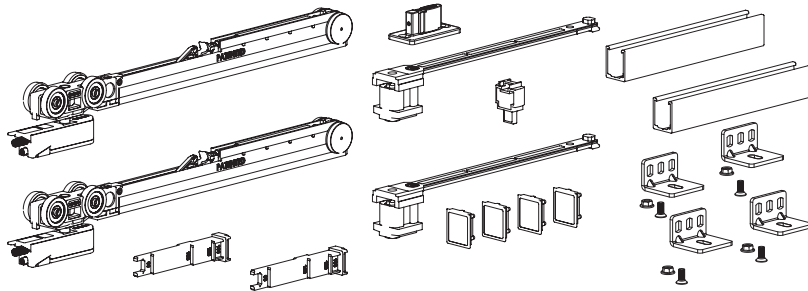



    
set **50kg** 7182

    
set **80kg** 7410

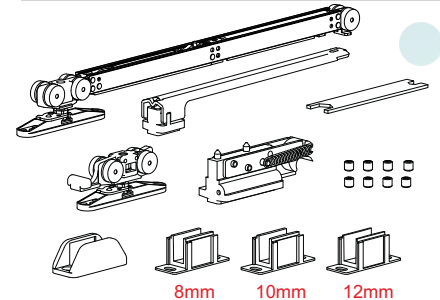

PVS Vetro 40 mehanizam





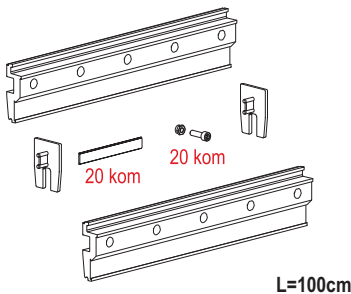

    
set metal 8713

PVS Vetro 40 nosači stakla za debljinu 8 i 10mm

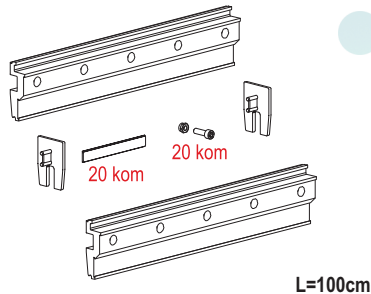





    
set **8mm** 5751

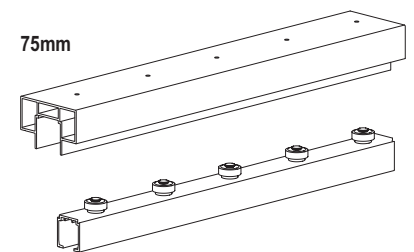

    
set **10mm** 5752

PVD Pocket set baze i gornje šine 200cm



    
kom SM 9002

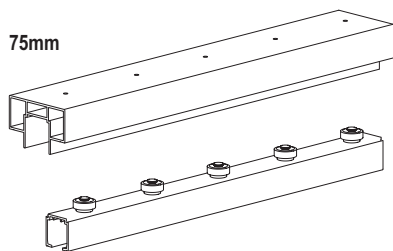

PVD Pocket set baze i gornje šine 250cm



    
kom SM 9001

PVD POCKET nosač četkice 3m



    
kom SM 9007

PVD POCKET baza nos. četkice 3m



    
kom SM 8999

PVD POCKET četkica za zid

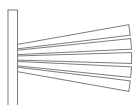

    
m SM 9000

PVD POCKET gumice za nos. četk.

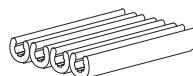

    
set SM 9003

Drag klizni sistem za drvena pregradna vrata

40/50/80kg

Dryo 30mm  
50mm

700mm  
MIN

Tehnički crteži i prikaz montaže mehanizma

