

TOALET KABINE

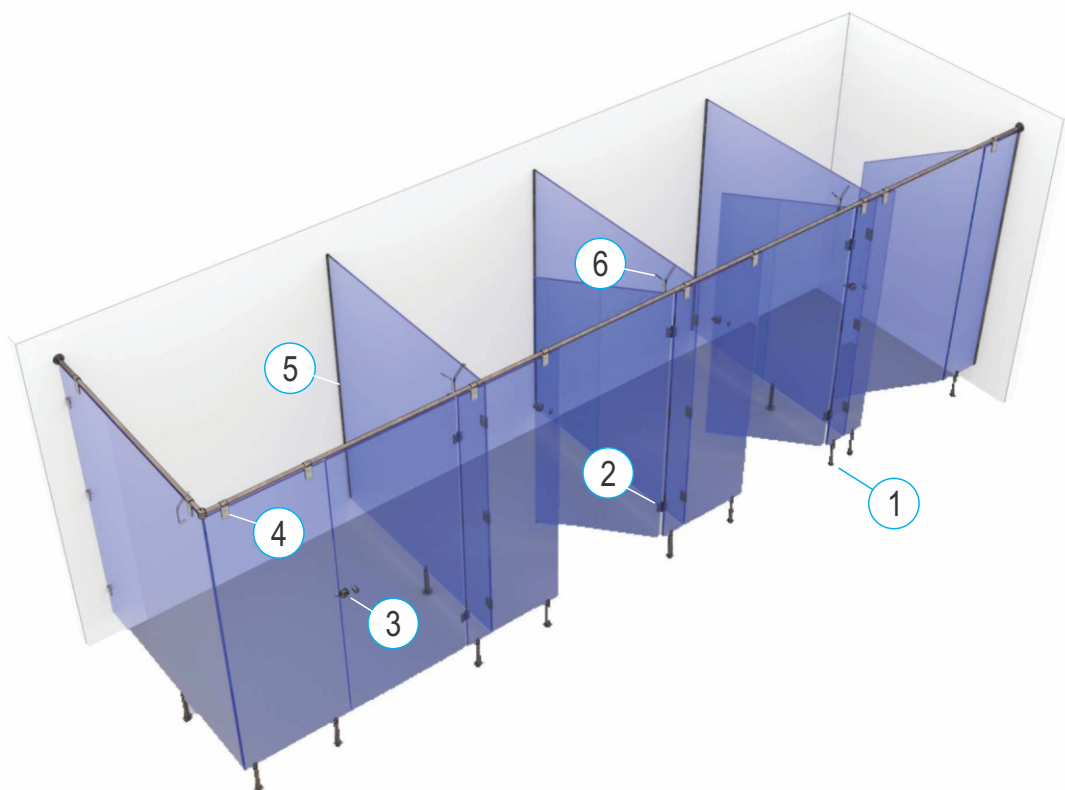

europrofil



SADRŽAJ



Nogice



1



Šarke



2



Brave i ručke



3



Spojni okov



4

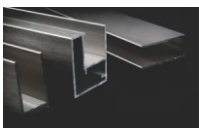

Cevi i profili

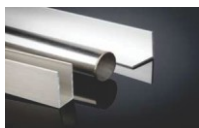

5



Čiviluci



6

OTK Nogice



Okov za toalet kabine

Nogice za toalet kabine

europrofil



EN 1670:2007



108mm-170mm	inox	kom	1962
OTK Nogica za kompakt ploču			

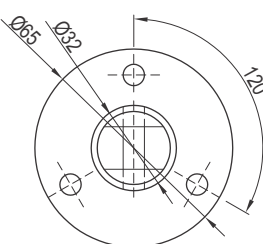
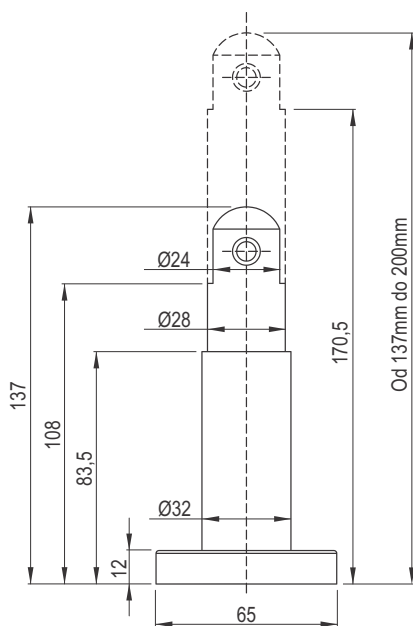

- Podesiva podnožja za ploču
- Regulacija od 108mm do 170mm
- INOX 304 - nerđajući čelik
- Potpuno vodootporan
- Prikladno za tuš kabinu



EN 1670:2007



205mm-372mm	inox	kom	7091
OTK Nogica za kompakt ploču			

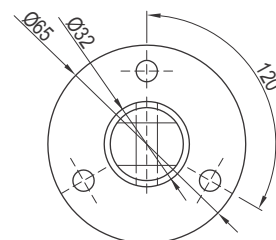
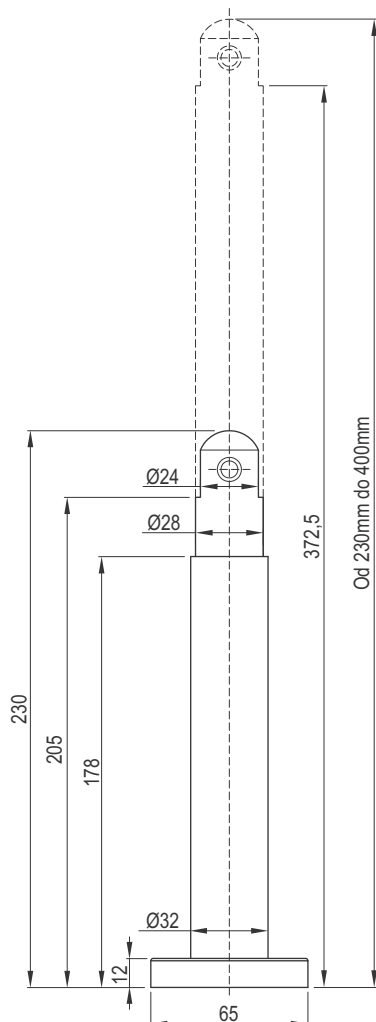

- Podesiva podnožja za ploču
- Regulacija od 205mm do 372mm
- INOX 304 - nerđajući čelik
- Potpuno vodootporan
- Prikladno za tuš kabinu

OTK Šarke

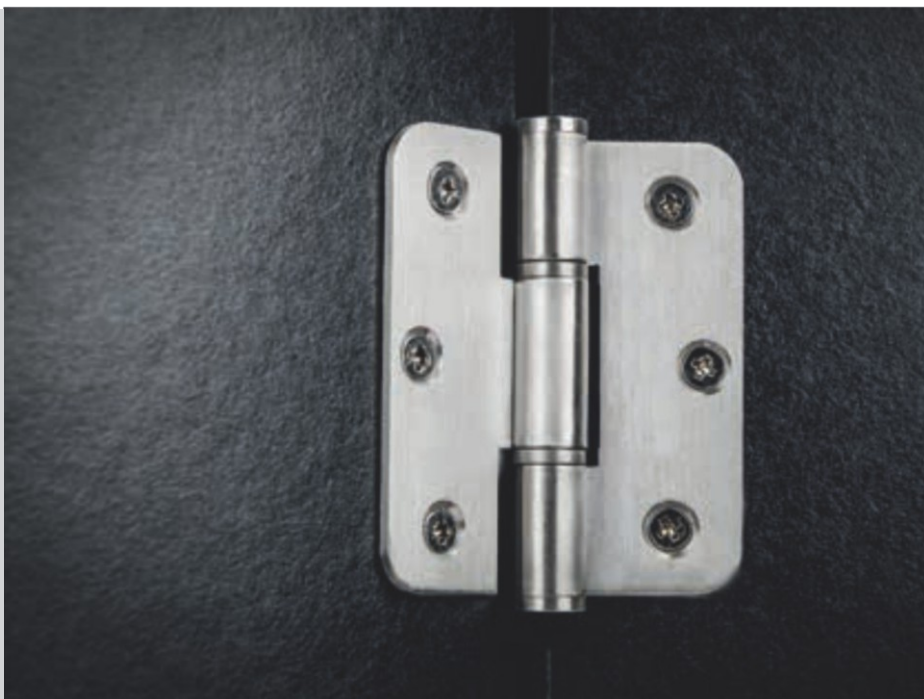

EN 1670:2007

- Sa ili bez opruge
- INOX 304 - nerđajući čelik
- Osovina od nerđajućeg čelika
- Prikladno za tuš kabinu

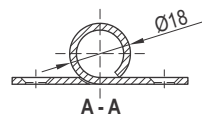
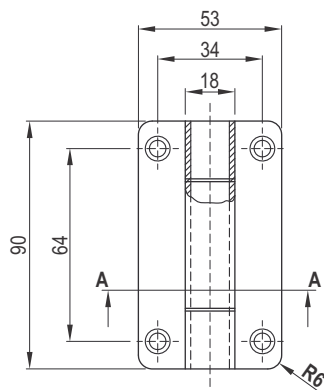

j.m.

šifra

90x53x2mm	inox	kom	4663	bez opruge
90x53x2mm	inox	kom	3672	sa oprugom

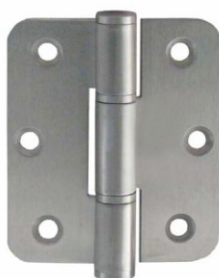

EN 1670:2007

- Bez opruge
- INOX 304 - nerđajući čelik
- Osovina od nerđajućeg čelika
- Prikladno za tuš kabinu

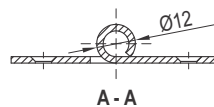
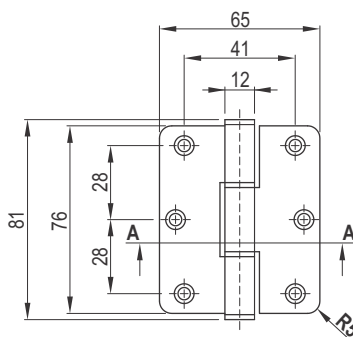

j.m.

šifra

76x65x2mm	inox	kom	1082	bez opruge
-----------	------	-----	------	------------

OTK Ručice i bravice



EN 1670:2007

- Ručkica za vrata
- INOX 304 - nerđajući čelik
- Prikladno za tuš kabinu

25x35mm	inox	kom	4699
OTK Ručica			

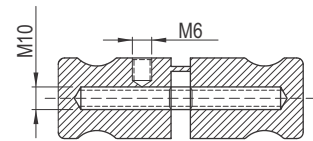
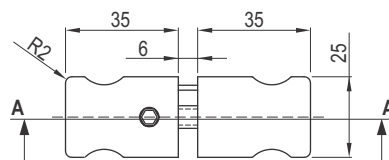

A - A

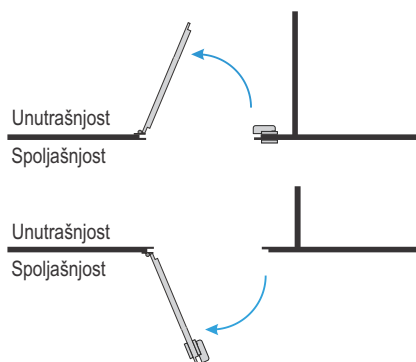

EN 1670:2007

- Zatvaranje za preklopna vrata.
- Indikator "slobodno" | "zauzeto"
- INOX 304 - nerđajući čelik
- Unutrašnja i spoljašnja instalacija
- Prikladno za tuš kabinu

Ø63	inox	kom	4659
OTK Brava sa indikatorom			

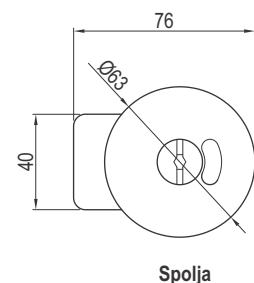
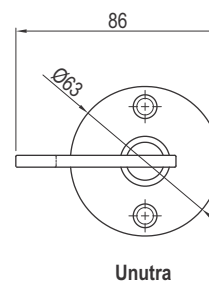
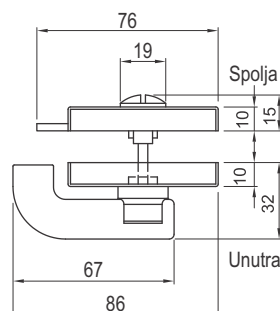

OTK Spojni okov

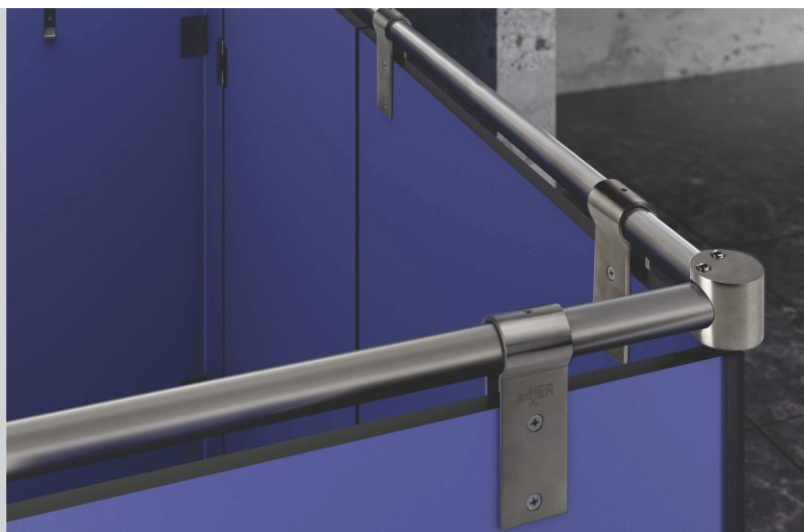

		j.m.	šifra
Ø64	inox	kom	5004
OTK Zidni nosač cevi			

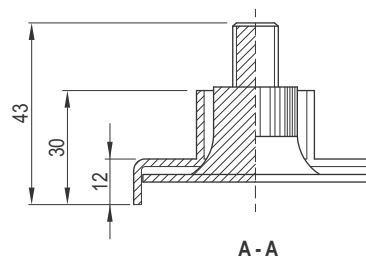
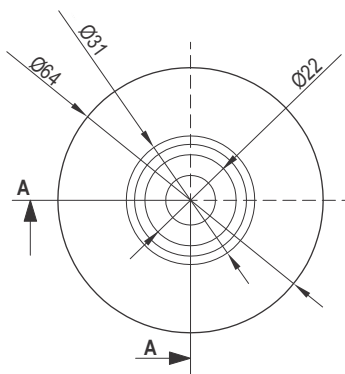

EN 1670:2007

- Zidni nosač cevi
- INOX 304 - nerđajući čelik



		j.m.	šifra
40x110mm	inox	kom	4402
OTK „U“ spoj cevi i komp. ploče			

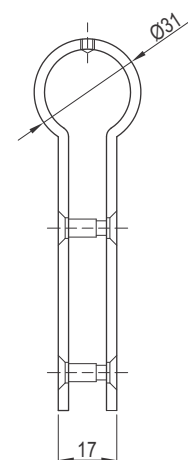
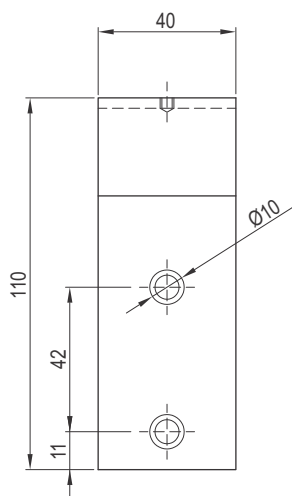

EN 1670:2007

- Spojnica za cev i ploču
- INOX 304 - nerđajući čelik



- 90° ili 90°+ 90° konektor za cev
- INOX 304 - nerđajući čelik

EN 1670:2007



Konektor 2 cevi / 90°

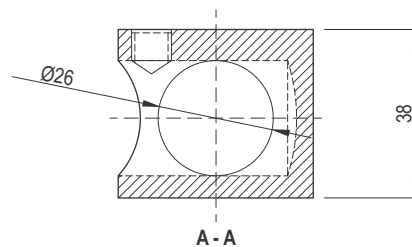
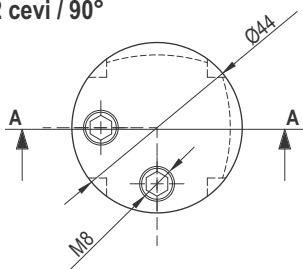

„ T ” Konektor 3 cevi / 90° + 90°

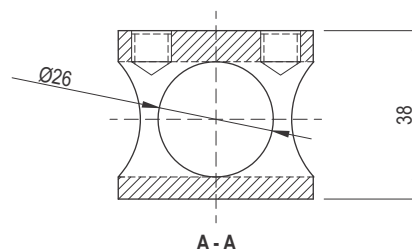
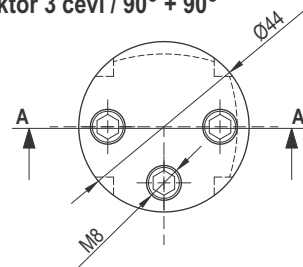

Ø44	inox	kom	1966	2 cevi / 90°
Ø44	inox	kom	1967	3 cevi / 90°+90°
OTK Konektori cevi				



- Cevi Ø25, L=2m ili L=3m
- INOX 304 - nerđajući čelik



EN 1670:2007



1m; 2m; 3m	inox	m	7089
OTK Cev Ø25 / 6m			

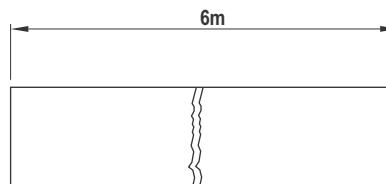
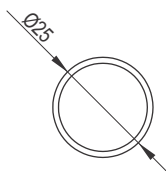

- Spoj cevi
- INOX 304 - nerđajući čelik



EN 1670:2007



39x25mm	inox	kom	6520
OTK Spoj cevi			

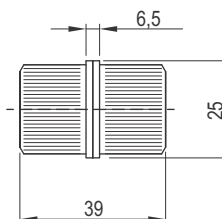
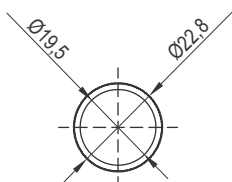

Okov za toalet kabine

Spojni okov za toalet kabine



- L ugao za povezivanje kompakt ploče i zida
- INOX 304 - nerđajući čelik



EN 1670:2007

		j.m.	šifra
40x43x43mm	inox	kom	3695
OTK Ugao 90°			

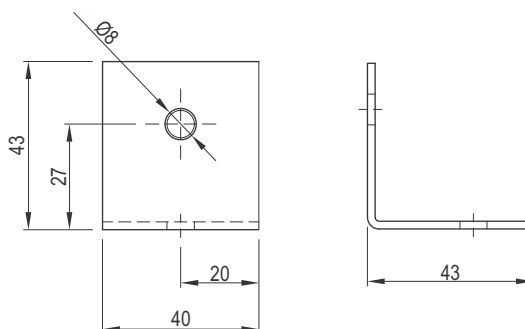

- U spoj za kompakt ploču
- INOX 304 - nerđajući čelik



EN 1670:2007

		j.m.	šifra
50x49x17mm	inox	kom	5180
OTK „U” spoj za kompakt ploču			

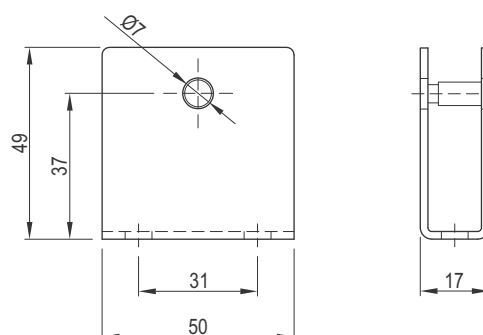

- L spoj za povezivanje kompakt ploče i zida
- INOX 304 - nerđajući čelik



EN 1670:2007

		j.m.	šifra
50x54x41mm	inox	kom	4101
OTK „L” spoj za kompakt ploču			

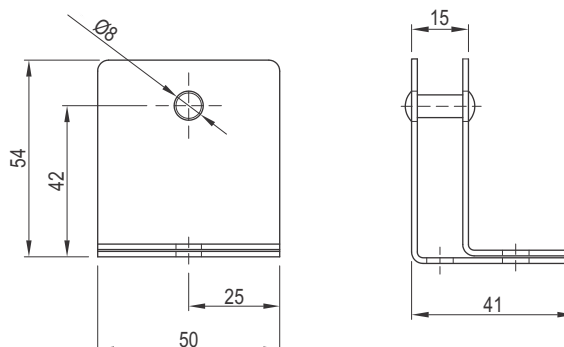

Okov za toalet kabine

Spojni okov za toalet kabine



- T spoj za povezivanje kompakt ploče i zida
- INOX 304 - nerđajući čelik



EN 1670:2007

		j.m.	šifra
50x54x67mm	inox	kom	5005
OTK Spoj „T” za kompakt ploču			

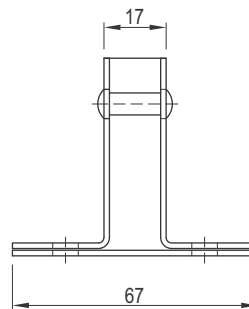
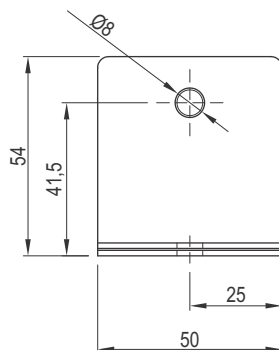

OTK INOX profili za kompakt ploče

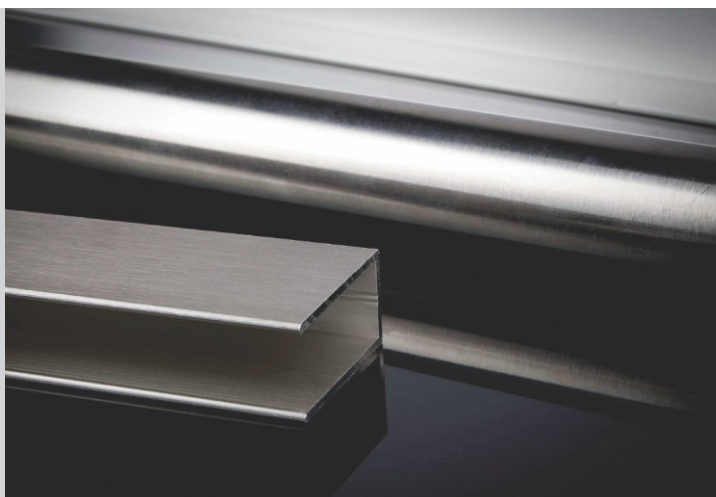

- „U” profil za kompakt ploču
- INOX 304 - nerđajući čelik



EN 1670:2007

		j.m.	šifra
15x20x1800mm	inox	kom	1968
OTK Profil „U” 1,8m - komp. ploča			

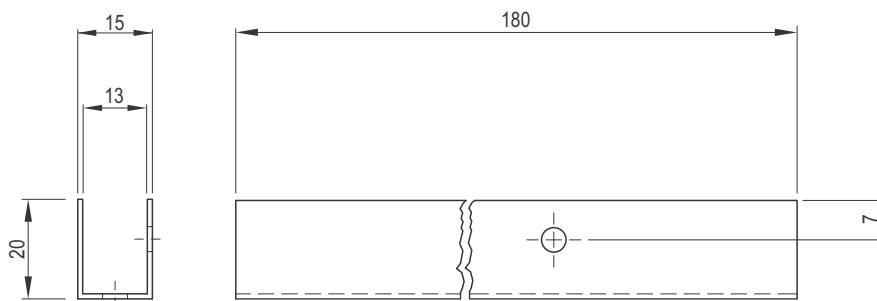

- „L” profil za kompakt ploču
- INOX 304 - nerđajući čelik



EN 1670:2007

		j.m.	šifra
33x33x1800mm	inox	kom	5243
OTK Profil „L” 1,8m - komp. ploča			

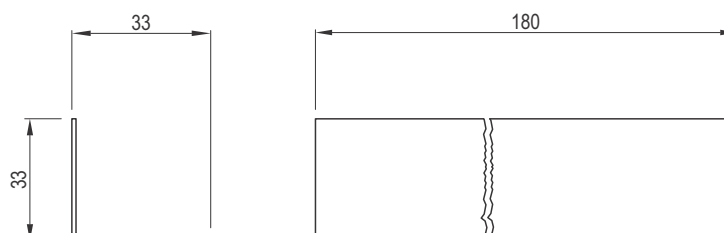



OTK Šrafovi i podloške za kompakt ploče



- Šraf sa mašinskim navojem za spoj kompakt ploče
- INOX 304 - nerđajući čelik



EN 1670:2007

		j.m.	šifra
12x4mm	inox	kom	3696
OTK Šraf za spoj kompakt ploče			

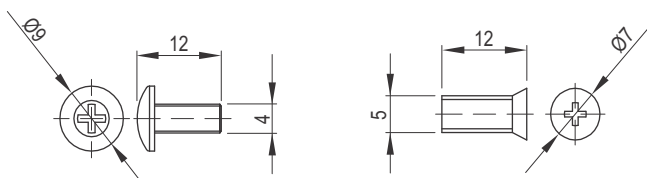

- Podloška za spoj kompakt ploče



		j.m.	šifra
20x26,5x0,8mm	siva	kom	4548
OTK Podloška za kompakt ploču			

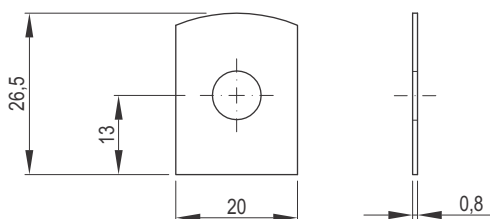



OTK Čiviluci



- Čiviluk d=18mm - 1 kuka
- INOX 304 - nerđajući čelik



EN 1670:2007

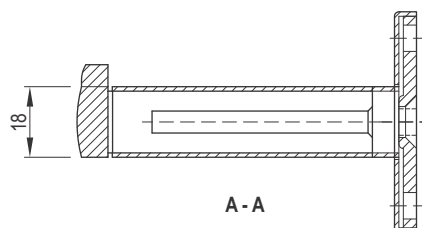
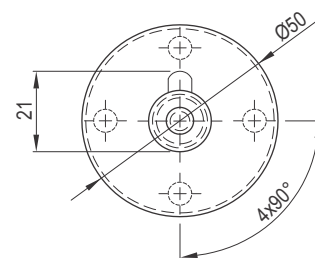
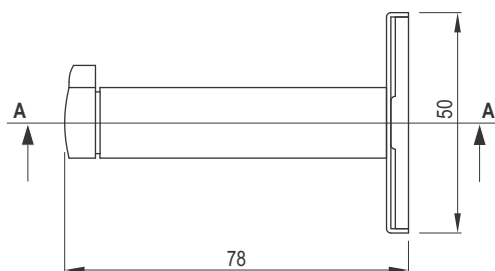

78x50mm inox kom 4205

OTK Čiviluk d=18mm 1 kuka

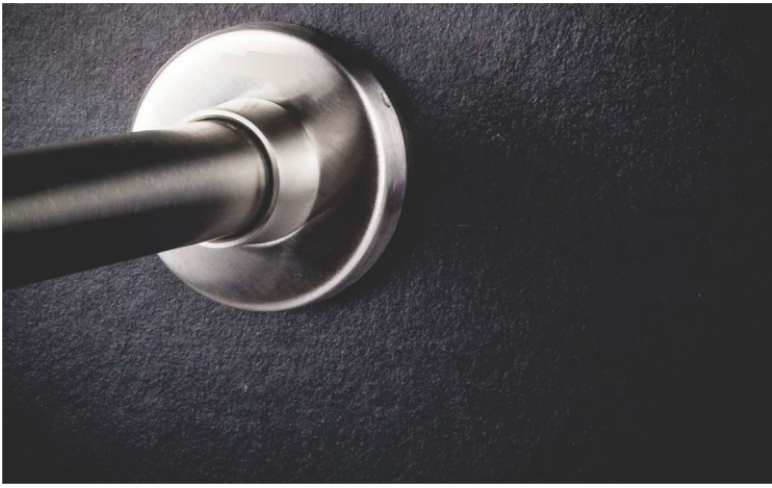

Slika	Naziv proizvoda	Šifra	J. M.	Materijal	VP cena	MP cena
	OTK Nogica / 205-372mm za kompakt ploču	7091	kom.	INOX 304	1.424,00	1.709,00
	OTK Nogica / 108-170mm za kompakt ploču	1962	kom.	INOX 304	1.350,00	1.620,00
	OTK Šarka / 90x53x2mm bez opruge	4663	kom.	INOX 304	559,00	671,00
	OTK Šarka / 90x53x2mm sa oprugom	3672	kom.	INOX 304	635,00	762,00
	OTK Šarka / 76x65x2mm bez opruge	1082	kom.	INOX 304	425,00	510,00
	OTK Ručica / 25x35mm bez opruge	4699	kom.	INOX 304	589,00	707,00
	OTK brava sa indikatorom Ø63	4659	kom.	INOX 304	1.037,00	1.245,00
	OTK Zidni nosač cevi Ø64	5004	kom.	INOX 304	768,00	922,00
	OTK „U” spoj cevi i kompakt ploče	4402	kom.	INOX 304	526,00	631,50
	OTK Konektor 2 cevi 90°	1966	kom.	INOX 304	1.036,00	1.243,50
	OTK Konektor 3 cevi 90° + 90°	1967	kom.	INOX 304	1.020,00	1.224,00

Slika	Naziv proizvoda	Šifra	J. M.	Materijal	VP cena	MP cena
	OTK Cev Ø25 6m	7089	m	INOX 304	513,00	616,00
	OTK spoj cevi 39x25mm	6520	kom.	INOX 304	527,00	632,50
	OTK Ugao 90° 40x43x43mm	3695	kom.	INOX 304	222,00	266,50
	OTK „U” spoj za kompakt ploču	5180	kom.	INOX 304	264,00	317,00
	OTK „L” spoj za kompakt ploču	4101	kom.	INOX 304	438,00	526,00
	OTK Spoj „T” za kompakt ploču	5005	kom.	INOX 304	438,00	526,00
	OTK Profil „U” 1,8m	1968	kom.	INOX 304	1.380,00	1.656,00
	OTK Profil „L” 1,8m	5243	kom.	INOX 304	1.589,00	1.907,00
	OTK Šraf za spoj kompakt ploče	3696	kom.	INOX 304	59,00	71,00
	OTK Podloška za kompakt ploču	4548	kom.	PVC	59,00	71,00
	OTK Čiviluk d=18mm 1 kuka	4205	kom.	INOX 304	360,00	432,00