







SGM 04 sistem za izradu drvenih plakarskih vrata

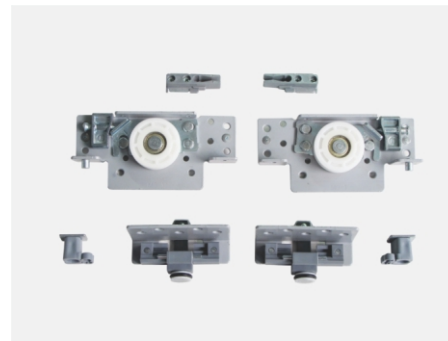
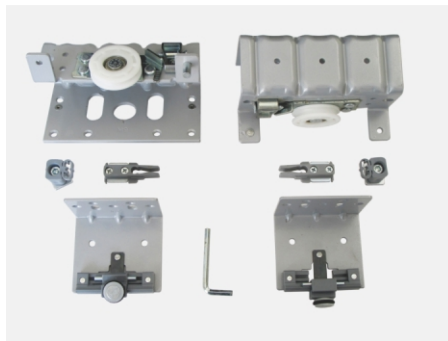

 80kg	 Drvo 18mm 22mm		 ± 3mm	
---	---	---	---	---

SGM 04 Met.meh.Spoljna vrata

SGM 04 Met.meh. Unutrašnja vrata



		šifra
set	metal	462

		šifra
set	metal	537

SGM 04-014 Gornja šina AL

SGM 04-013 Donja šina AL

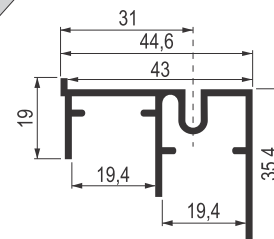
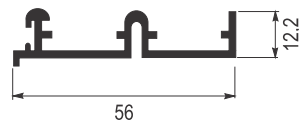
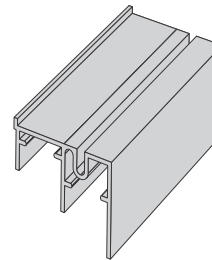
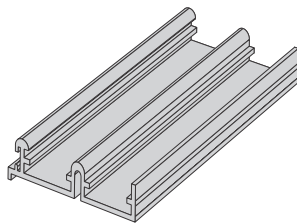

		šifra
m	SB	464

		šifra
m	SB	465

Prodajne dimenzije šina (m): 1; 1,5; 2; 3; 4; 6.

Tehnički crteži i prikaz montaže mehanizma

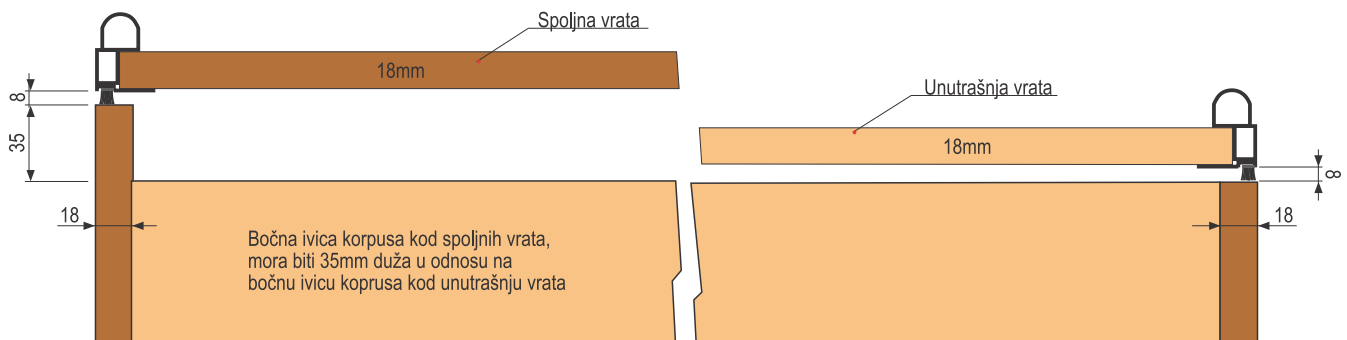

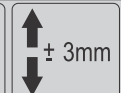
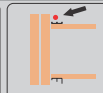
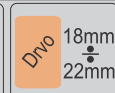

Tehnički crteži i prikaz montaže mehanizma

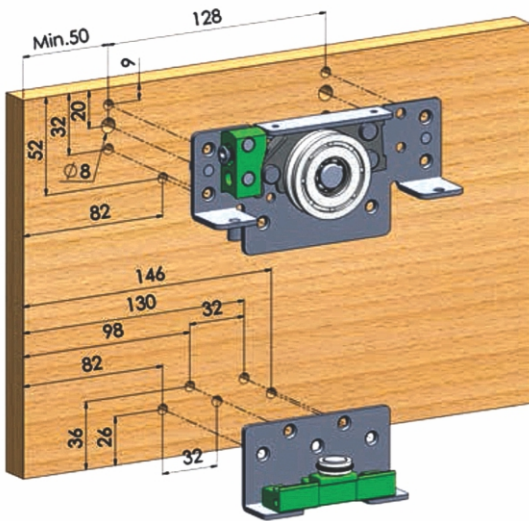

Prikaz montaže unutrašnjeg mehanizma

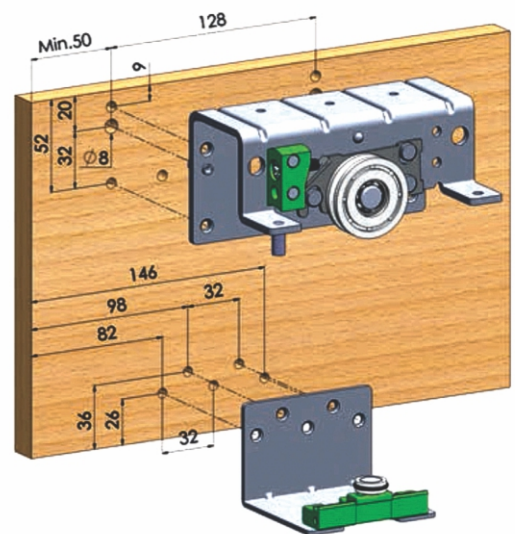

Prikaz montaže spoljašnjeg mehanizma

